

LG-3660 Standard Shower Pan

- Standard Threshold / Center Drain
- Satin Finish
- Solid Surface casting in one piece construction
- Acrylic blend
- Limited Warranty (15 years)
- Manufactured in Mexico

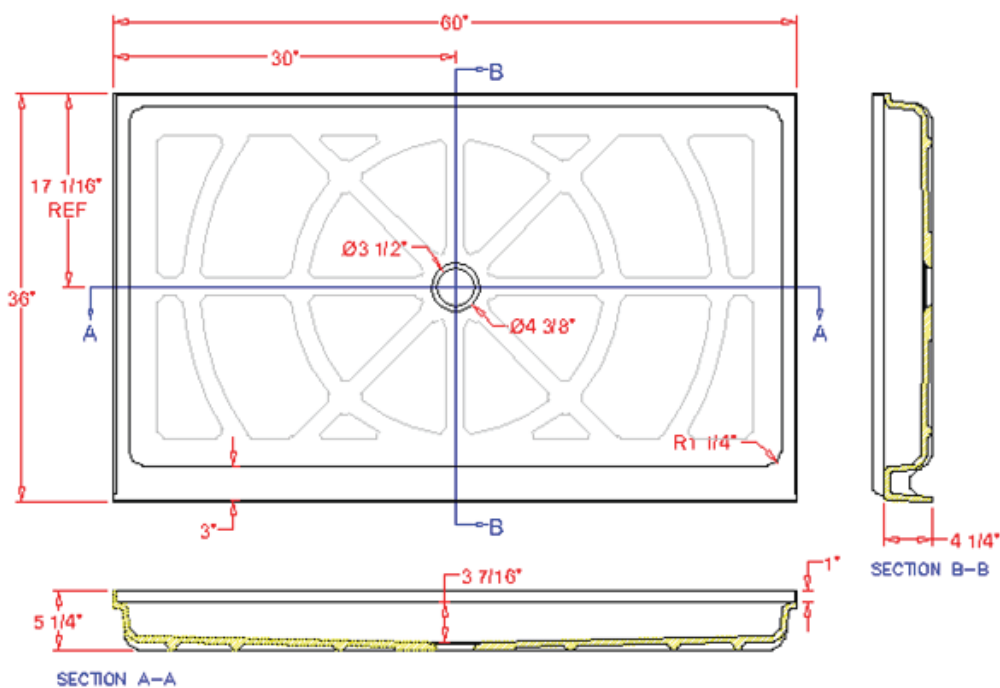

Available Colors

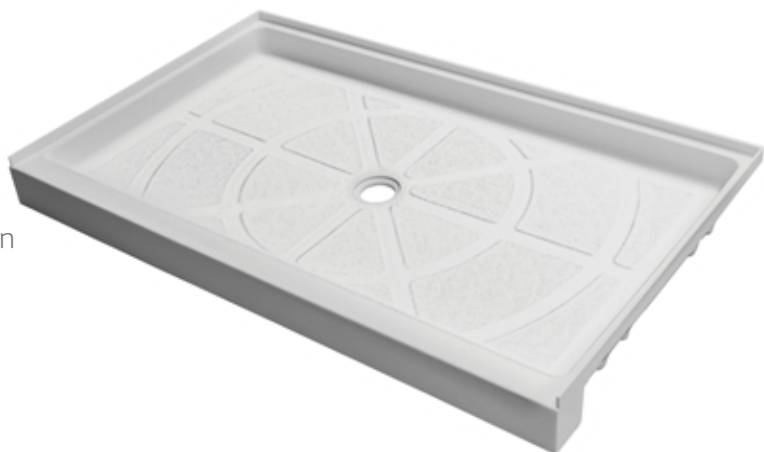
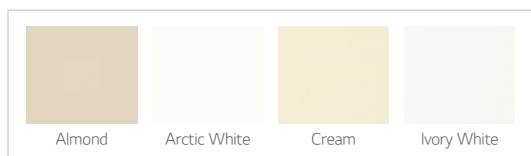

Dimensions

	Width	Length	Depth
Overall	36" (914mm)	60" (1524mm)	5 1/5" (132 mm)
Inner	31 7/10" (805 mm)	57 1/2" (1461mm)	3 2/5" (86 mm)

* Metric conversions are approximate
** Dimensions can vary by 1/16"